

LT-800 DMX controller



LT-800 DMX512 controller is the output signal of international standard DMX/1990. It not only can control all the LED lights in the market as long as can receive the standard DMX signal, but also can work with our DMX Decoder to control general LED lights without DMX512.

LT-800 DMX512 Controller is easy to operate with a LCD screen. Available with wireless control and keying control on the changing modes, speed and brightness, automatic timing and more than 30 modes for your choices. Supporting pause in Changing modes and very easy to keep the specific color.

1. Product parameter

LT-800	
Working Voltage	DC12 (with an adapter to convert AC100-240V to DC12V)
Power Consumption	<2W
Output Signal	DMX512/1990
Output Loop	1 Port
Transmission Speed	250Kbps
Function Mode	39 modes
Control Quantity	512 DMX channels(170 pixels)
Working Temperature	-30°C~65°C
Product Dimensions	L163xW108xH40mm
Package Dimensions	L260xW132xH46mm
Weight(G.W)	760g

1

2. Function features

1. With LCD screen, easy to operate in showing all functions.
2. Built-in perpetual calendar, real-time display system clock, can be set up to play different programs in any time, Monday to Sunday or holiday.
3. 30 lighting modes. Such as, 7 color, skipping synchronism, smooth synchronism, color flow, color chasing, color smooth and flow and Meteor shower trailing, etc.
4. Multilevel changing speed, brightness and RGB grey scale adjustment for your choices.
5. Feel free to define many changing modes into a step, 8 independent cycle steps maximum.
6. Output with international Standard signal DMX512/1990, can control 512 DMX channels (170 full color RGB pixels)
7. Support different output ports like standard XLR-3, RJ45 and European terminals. Etc.
8. with the functions of anti-interference and automatic breakdown recovery.

3. Construction drawing

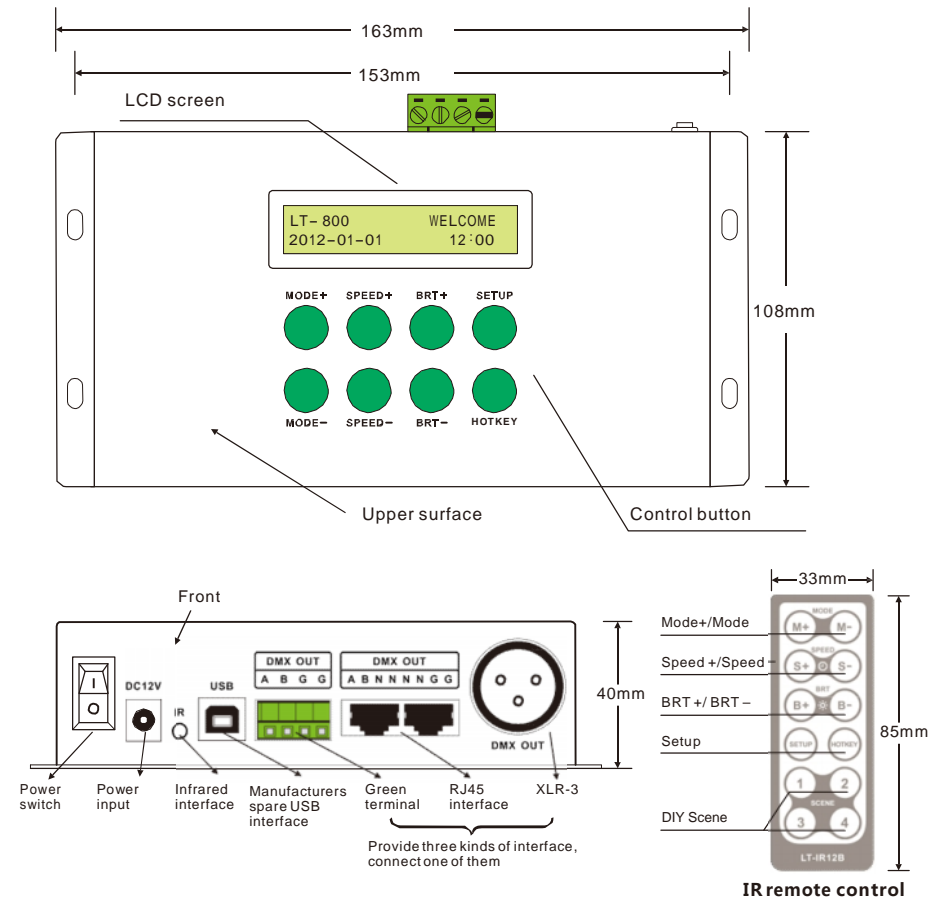

2

4. Operating instructions

8 function keys on the controller, MODE+/MODE-(mode),SPEED+/SPEED-(speed), BRT+/BRT-(brightness),SETUP(setup),HOTKEY(function)

1. Basic Control

- Pressing MODE+/MODE- button, to switch general change modes 1-30, automatic change modes 31-38 and automatic timing run change modes 39.

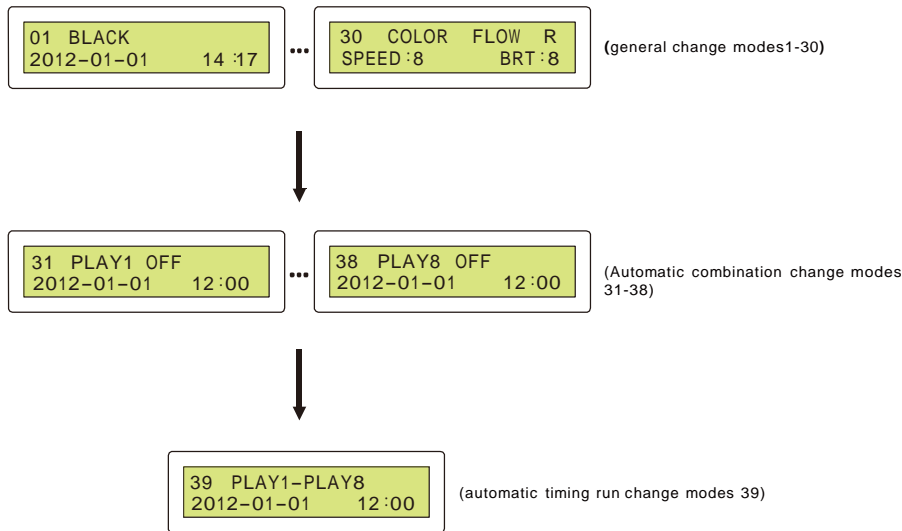

- Under the general change modes, pressing SPEED+/SPEED- button to adjust the speed of the change modes; Pressing BRT+/BRT- button to adjust the brightness of the change modes.
- Pressing SETUP button for 3 seconds, then enter into the submenu setting surface of general change modes or automatic change modes .Pressing MODE+/MODE- button to switch the submenu page. Pressing SPEED+/SPEED- button to sway the configuration item .Pressing BRT+/BRT- to change the parameter values of the configuration item. Pressing SETUP button to Exit the submenu of setting surface.
- Pressing HOTKEY button for 3 seconds, enter into the submenu of address operation, pressing HOTKEY to Exit the submenu of address operation.

2. Submenu operational approach of general change modes 1-30

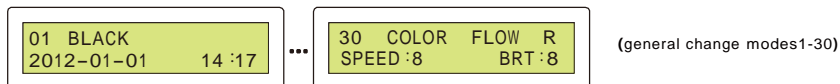

Following form is general change functional modes.

Note: For mode 2-8, static color will be showed when minimum speed 1 and maximum speed 8, and speed 2-7 is strobe speed.

No.	DisplayInstruction	Instruction	No.	DisplayInstruction	Instruction
1	BLACK		16	WHITE FADE	SPEED/BRIGHTNESS ADJUSTMENT
2	STATIC RED	SPEED/BRIGHTNESS ADJUSTMENT	17	COLOR FADE	SPEED/BRIGHTNESS ADJUSTMENT
3	STATIC GREEN	SPEED/BRIGHTNESS ADJUSTMENT	18	COLOR COVER	SPEED/BRIGHTNESS ADJUSTMENT
4	STATIC BLUE	SPEED/BRIGHTNESS ADJUSTMENT	19	COLORSPLIT	SPEED/BRIGHTNESS ADJUSTMENT
5	STATIC YELLOW	SPEED/BRIGHTNESS ADJUSTMENT	20	COLOR CLOSE	SPEED/BRIGHTNESS ADJUSTMENT
6	STATIC PURPLE	SPEED/BRIGHTNESS ADJUSTMENT	21	RGB CHASE F	SPEED/BRIGHTNESS ADJUSTMENT
7	STATIC CYAN	SPEED/BRIGHTNESS ADJUSTMENT	22	RGB CHASE R	SPEED/BRIGHTNESS ADJUSTMENT
8	STATIC WHITE	SPEED/BRIGHTNESS ADJUSTMENT	23	COLOR CHASE F	SPEED/BRIGHTNESS ADJUSTMENT
9	RGB CHANGE	SPEED/BRIGHTNESS ADJUSTMENT	24	COLOR CHASE R	SPEED/BRIGHTNESS ADJUSTMENT
10	COLOR CHANGE	SPEED/BRIGHTNESS ADJUSTMENT	25	WHITE METEO F	SPEED/BRIGHTNESS ADJUSTMENT
11	RG SMOOTH	SPEED/BRIGHTNESS ADJUSTMENT	26	WHITE METEO R	SPEED/BRIGHTNESS ADJUSTMENT
12	RB SMOOTH	SPEED/BRIGHTNESS ADJUSTMENT	27	COLOR METEO F	SPEED/BRIGHTNESS ADJUSTMENT
13	GB SMOOTH	SPEED/BRIGHTNESS ADJUSTMENT	28	COLOR METEO R	SPEED/BRIGHTNESS ADJUSTMENT
14	RGB SMOOTH	SPEED/BRIGHTNESS ADJUSTMENT	29	COLOR FLOW F	SPEED/BRIGHTNESS ADJUSTMENT
15	COLORSMOOTH	SPEED/BRIGHTNESS ADJUSTMENT	30	COLOR FLOW R	SPEED/BRIGHTNESS ADJUSTMENT

At status of Mode 1-30, press button SETUP for 3 seconds to enter submenu, see the form below.

No.	Submenu function (Press MODE+/- to change menu below)	LCD display condition	Setting methods
1	PIXEL QUANTITY ADJUSTMENT	PIXEL NUMBER :032 RANGE :4-170	Press BRT+/- increase or decrease pixel quantity
2	OPERATION TIMES ADJUSTMENT	RUN TIMES :255 000=NOT RUNNING	Press BRT+/- increase or decrease operation times (only work between mode 31-38)
3	RGB OUTPUT GREY LEVEL ADJUSTMENT	RGB BRIGHT ADJ R255 G255 B255	Press BRT+/- to adjust each RGB level, press SPEED+/- to change R, G, or B
4	MODE RECOVER DEFAULT	LOAD DEFAULT SET PRESS BRT+ - KEY	Press BRT+/- to recover default

Finish each parameter setting, then press button SETUP to exit.

3. Sub Menu of Automatic change modes 31-38

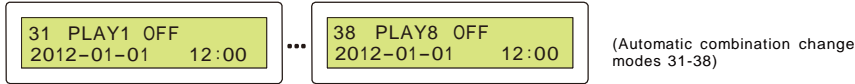

When you in the situation of 31-38 modes, press set up key for 3 seconds entering into the Submenu, such as below:

No.			
1	setting switch state		Press "BRT+/-" to set the switch state, Select "ON" to 39 automatic circle modes
	store the times of operating (it is convenient to set basic on the last time setting)		Press "SPEED+/-" enter into "OPEN" (turn out the operation times of 1-30 modes), then Press "BRT+" to confirm.
	save the setting about the operation time		Press "SPEED+/-" enter into "SAVE" (save the setting about the operation time), Press "BRT+/-" to confirm.
2	Setting operation week		Press "SPEED+/-" then you can see the "MTWTFSS"(Monday to Sunday) and 00:00 00:00(time), press "BRT+/-" to choose(if you do not choose the Monday to Sunday, the screen will appear _ the one mark)
3	Operate time and date 1		Press "SPEED+/-" you can press "BRT+/-" choose 0101-0103(date) and 00:00-00:00(time) to adjust date and time.
4	Operate time and date 2		Press "SPEED+/-" you can press "BRT+/-" choose 0101-0103(date) and 00:00-00:00(time) to adjust date and time.
5	Operate time and date 3		Press "SPEED+/-" you can press "BRT+/-" choose 0101-0103(date) and 00:00-00:00(time) to adjust date and time.
6	System clock setting		Press "SPEED+/-" to choose "2012-01 01"(date), 12:00(time), press "BRT+/-" to adjust date and time.
7	RGB sequence setting		Press "BRT+/-" to adjust the RGB brightness sequence, for example: RGB, RBG, GRB, GBR, BRG, BG.
8	Modes restore default value		Press "BRT+/-" restore the automatic default value.

Finish each parameter setting, then press button SETUP to exit.

4. Automatic timing run mode 39

When set to the 39th mode, according to the preset switch condition and running time of automatic change modes 31-38 to run the corresponding mode. The submenu only has the items that restore to default status (Please Carefully Choose this item)

5. Connection schemes

1. Connect to the LED Lamps with DMX chip inside

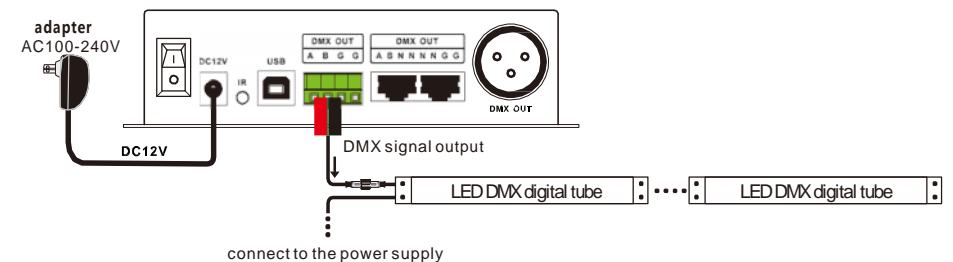
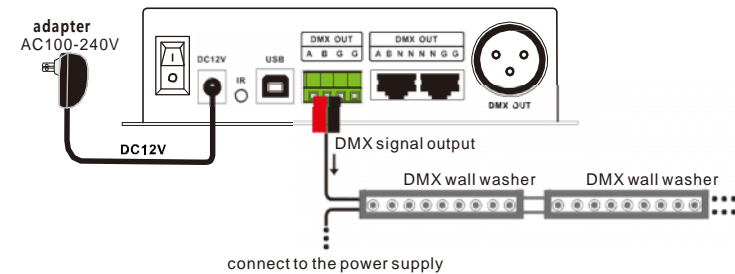
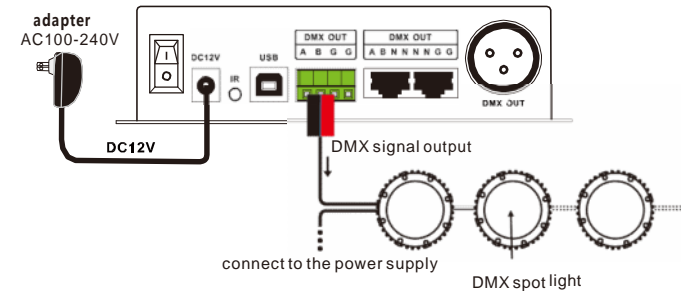

[Note] please confirm the LED lamp you connected can receive standard DMX512 signal, otherwise, it can't work properly

2. connect to the DMX driver

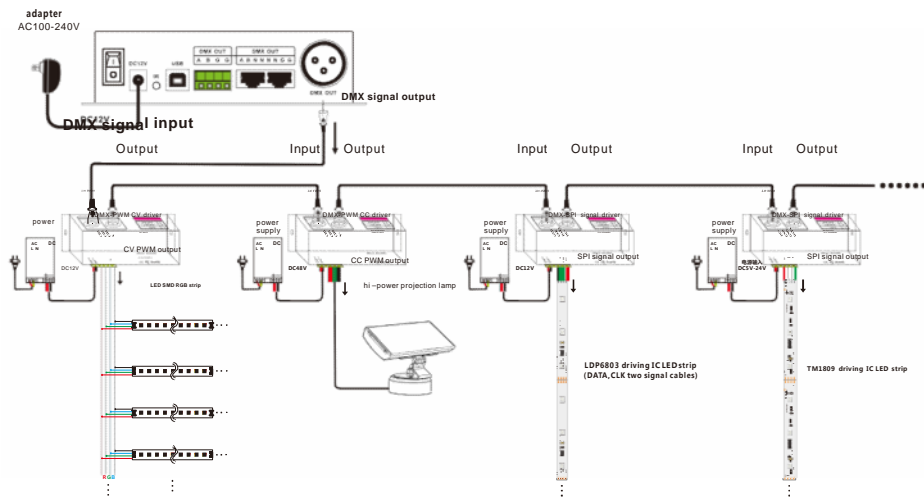

5. Attention

1. The product shall be installed and serviced by a qualified person.
2. This product is non-waterproof. Please avoid the sun and rain. When installed outdoors please ensure it is mounted in a water proof enclosure.
3. Good heat dissipation will prolong the working life of the controller. Please ensure good ventilation.
4. Please check if the output voltage of any LED power supplies used comply with the working voltage of the product.
5. Please ensure that adequate sized cable is used from the controller to the LED lights to carry the current. Please also ensure that the cable is secured tightly in the connector to avoid the accidents due to overheat and poor contact on the wire.
6. Ensure all wire connections and polarities are correct before applying power to avoid any damages to the LED lights.
7. If a fault occurs please return the product to your supplier. Do not attempt to fix this product by yourself.

6. Warranty Agreement

1. We provide lifelong technical assistance with this product:
 - A 3 year warranty is given from the date of purchase. The warranty is for free repair or replacement and covers manufacturing faults only.
 - For faults beyond the 3 year warranty we reserve the right to charge for time and parts.
2. Warranty exclusions below:
 - Any man-made damages caused from improper operation, or connecting to excess voltage and overloading.
 - The product appears to have excessive physical damage.
 - Damage due to natural disasters and force majeure.
 - Warranty label, fragile label and unique barcode label have been damaged.
 - The product has been replaced by a brand new product.
3. Repair or replacement as provided under this warranty is the exclusive remedy to the customer. Ltech shall not be liable for any incidental or consequential damages for breach of any stipulation in this warranty.
4. Any amendment or adjustment to this warranty must be approved in writing by Ltech only.

★ This manual only applies to this model. Ltech reserves the right to make changes without prior notice.